

Article number: 390204904562310
 Description: Worm gear
 VF 49-FA2-45-63B14

Measures

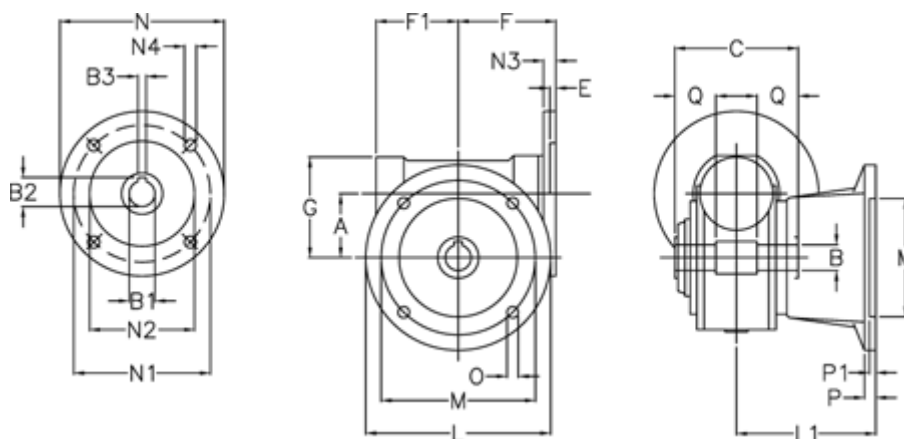

| | | |
|------------|----------|----------|
| A = 49.5 | F1 = 63 | N2 = 60 |
| B = 25 H7 | G = 80 | N3 = 7 |
| B1 E7 = 11 | L = 125 | N4 = 6 |
| B2 = 12.8 | L1 = 115 | O = 10.5 |
| B3 H9 = 4 | M = 90 | P = 12 |
| C = 82 | M1 = 70 | P1 = 10 |
| E = 3 | N = 90 | Q = 22.5 |
| F = 70 | N1 = 75 | |